

Health and safety

The use of any electrical appliance requires the following common sense safety rules. **Please read these instructions carefully before using the product.**

- **WARNING: This appliance incorporates a heating element which is subject to residual heat after use.**
- **WARNING: Misuse of the appliance could cause personal injury.**
- CAUTION: To prevent damage to the appliance, do not use alkaline cleaning agents when cleaning, use a soft cloth and mild detergent.
- This appliance can be used by children aged from 8 years and above if they have been given supervision or instruction concerning the use of the appliance in a safe way and if they understand the hazards involved. Cleaning and user maintenance shall not be made by children unless they are older than 8 and supervised. Keep the appliance and its cord out of the reach of children aged less than 8 years.
- For care and cleaning, refer to the relevant sections in these instructions.
- If the mains cable is damaged, it must be replaced by the manufacturer, its service agent or similarly qualified person in order to avoid a hazard.
- Appliances can be used by persons with reduced physical, sensory or mental capabilities or lack of experience and knowledge if they have been given supervision or instruction concerning use of the appliance in a safe way and understand the hazards involved.
- Children shall not play with the appliance.
- This appliance is intended to be used in household and similar applications such as: farm houses, by clients in hotels, motels and other residential type environments, and bed and breakfast type environments. It is not suitable for use in staff kitchen areas in shops, offices and other working environments in order to avoid a hazard.
- This product is not suitable for use in altitudes above 2000m.
- This appliance incorporates an earth connection for functional purposes only.
- If the supply cord is damaged, it must be replaced by the manufacturer, its service agent or similarly qualified persons in order to avoid a hazard.
- CAUTION: In order to avoid a hazard due to inadvertent resetting of the thermal cut-out, this appliance must not be supplied through an external switching device, such as a timer, or connected to a circuit that is regularly switched on and off by the utility.
- The coffee-maker shall not be placed in a cabinet when in use.
- The Milk frother Nozzle becomes very hot during use & this may cause burn in case of contact, therefore avoid any direct contact with Nozzle.

Exclusions

Morphy Richards shall not be liable to replace or repair the goods under the terms of the guarantee where:

- 1 The fault has been caused or is attributable to accidental use, misuse, negligent use or used contrary to the manufacturer's recommendations or where the fault has been caused by power surges or damage caused in transit.
- 2 The appliance has been used on a voltage supply other than that stamped on the products.
- 3 Repairs have been attempted by persons other than our service staff (or authorised dealer).
- 4 The appliance has been used for hire purposes or non domestic use.
- 5 The appliance is second hand.
- 6 Morphy Richards reserves the right not to carry out any type of servicing under the guarantee at its discretion.
- 7 Plastic filters for all Morphy Richards kettles and coffee makers are not covered by the guarantee.
- 8 Batteries and damage from leakage are not covered by the guarantee.
- 9 This guarantee does not confer any rights other than those expressly set out above and does not cover any claims for consequential loss or damage. This guarantee is offered as an additional benefit and does not affect your statutory rights as a consumer. Morphy Richards products are intended for household use only. See usage limitations within the location safety instructions.

Other safety considerations

Location

- Always locate your appliance away from the edge of the worktop.
- Ensure that the appliance is used on a firm, flat surface.
- Do not use the appliance outdoors or near water.

- **WARNING: Do not place the appliance onto a metal tray or metal surface whilst in use.**

Mains cable

- Do not let the mains cable hang over the edge of the worktop where a child could reach it.
- Do not let the mains cable run across an open space e.g. between a low socket and a table
- Do not let the mains cable run across a cooker or other hot area which might damage the cable.
- The mains cable should reach from the socket to the base unit without straining the connections.

Personal safety

- **WARNING: To protect against fire, electric shock and personal injury do not immerse cord, plug and appliance in water or any other liquid.**
- Unplug from the outlet before cleaning.
- Allow to cool before putting on or taking off parts and before cleaning.
- Do not move the Coffee Maker while switched on.
- The use of attachments or tools not recommended or sold by Morphy Richards, may cause fire, electric shock or injury.
- Do not use the appliance for any use other than its intended purpose.
- Do not place the appliance on or near a hot gas or electric burner or in a heated oven.
- **WARNING: The appliance must not be immersed for cleaning.**
- **CAUTION: To prevent damage to the appliance, do not use alkaline cleaning agents when cleaning. Use a soft cloth and detergent.**

Electrical requirements

Should the fuse in the mains plug require changing, replace it with a fuse of the same rating as originally fitted.

WARNING: This appliance must be earthed.

Product Overview

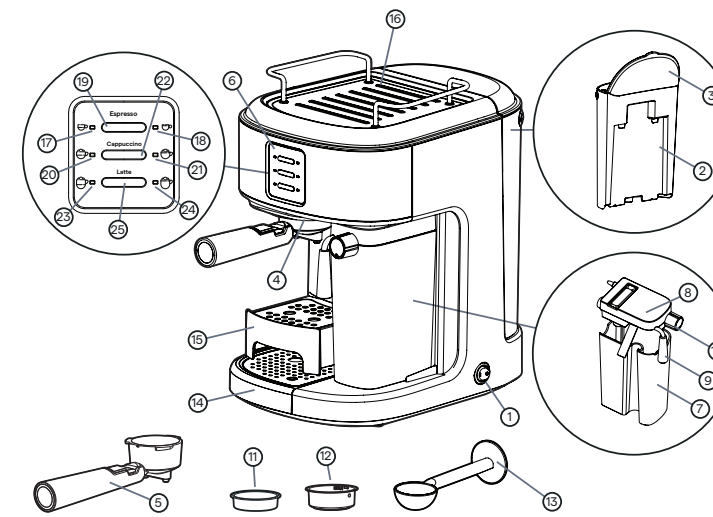

- | | | |
|------------------------------|---|---|
| 1 On/off switch | 13 Tamping Spoon | 21 Large cup cappuccino and milk foam light |
| 2 Water Tank | 14 Removeable drip tray and grid | 22 Cappuccino Small & Large Cup Select Button |
| 3 Water Tank Lid | 15 Drip Tray Stand | 23 Small cup latte and cleaning light |
| 4 Brew Head | 16 Cup Storage | 24 Large cup latte and cleaning light |
| 5 Porta-filter | 17 1 cup espresso and manual dispense light | 25 Latte Small & Large Cup Select and cleaning button |
| 6 Control Panel | 18 2 cup espresso and manual dispense light | |
| 7 Milk Tank | 19 Espresso 1 and 2 Cup and manual dispensing select button | |
| 8 Milk Tank Lid | 20 Small cup cappuccino and milk foam light | |
| 9 Milk Frother Nozzle | | |
| 10 Milk Frother Control Knob | | |
| 11 1 Cup Filter | | |
| 12 2 Cup Filter | | |

Before First Use

Remove all packaging. Wash the water tank (2), milk tank (7), porta-filter (5), 1 cup (11) & 2 cup (12) filters and tamping spoon (13) in warm soapy water. Rinse and dry thoroughly. Remove any labels from the product

IMPORTANT: Prior to first use it is important that water is flushed through the system and the machine is primed for making coffee.

NOTE: You may hear a pumping sound when water is passing through the system for the first time. This is normal and is caused by the air escaping from the system. The noise will cease after around 20 seconds.

Priming the Coffee Machine

To prime the unit run a cappuccino cycle with water only by following the steps below:

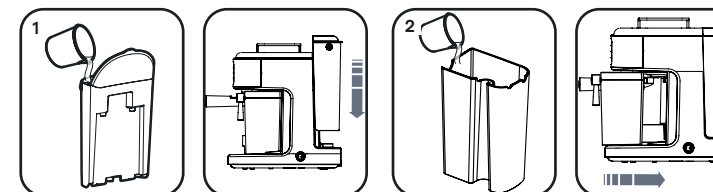

Fill water tank (2) to the "Max" level, replace the lid (3), remove the red plug from the underneath of the tank and re-attach to the machine.

Fill the milk tank (7) with water to the "Max" level, replace the lid (8) and attach to the machine.

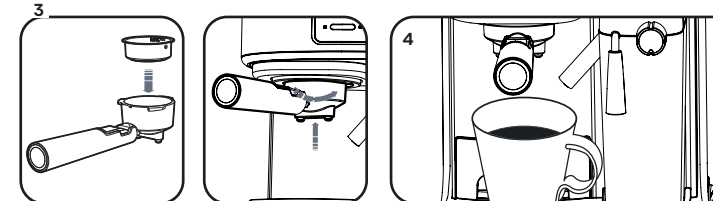

Select one of the filters (11 or 12) and place it in the porta-filter (5). Place the porta-filter into the brew head (4) ensuring it is properly locked and place a cup under it.

Make sure the tip of the frothed milk dispensing tube is inside the cup. Plug the machine into an appropriate socket. Turn the on/off switch (1) to "I".

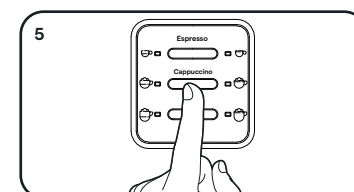

The six control panel lights will start to flash. When the lights become solid, press the cappuccino button (14) twice. Once this process is completed, the six control panels will become solid. Your machine has been primed and is ready to use.



Please read and keep these instructions for future use

Espresso Machine
With milk frother

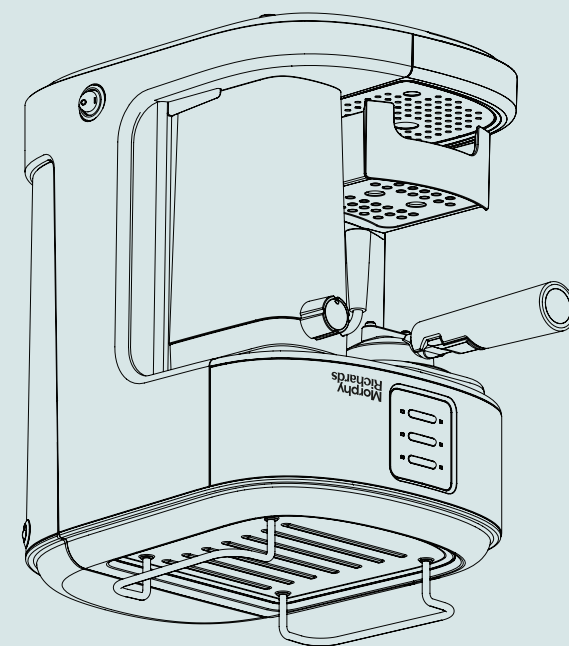

Morphy Richards

Contact us

If you are having a problem with your appliance or just need advice, contact us at Morphy Richards. Please have the product name, model number and serial number to hand, this will help us to deal with your enquiry quicker.

www.morphyrichards.co.uk

hello@morphyrichards.co.uk



M
R.

UK
CA CE

www.morphyrichards.com

CM172023MUK A3 Rev1

Operating Instructions

Filling The Water Tank (2)

To fill the water tank, remove it from the unit and fill under the tap between the "MIN" and "MAX" markings on the tank. Alternatively, use bottled or filtered water (see Descaling). Close the water tank lid (3) and ensure the tank is re-attached securely to the unit.

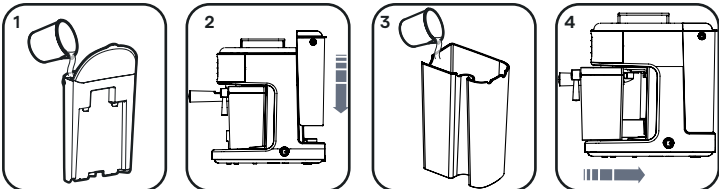

Select Your Filter

For a single shot – use the 1 cup filter (11)
For a double shot or 2 single shots – use the 2 cup filter (12)

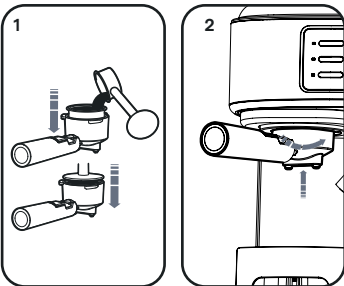

Selecting Your Cup

Pull out the drip tray stand (15) if you are using a small "demitasse" cup to brew espresso or when using a larger cup to brew latte or cappuccino stand your cup on the removeable drip tray and grid (14).

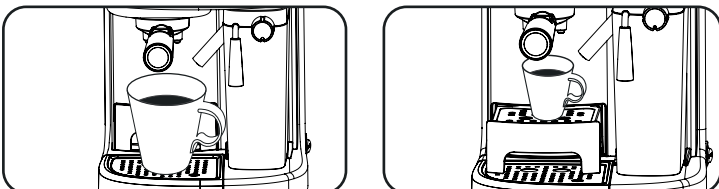

Turning the Unit On

Plug the machine into an appropriate socket. Turn the on/off switch (1) to "I". The six control panel lights will start to flash until the water reaches temperature. When the six lights become solid, your Espresso maker is ready to use.

Select The Function

Preparing Cappuccino

Before brewing cappuccino, turn the froth control knob on the milk tank to middle position. You can adjust the quantity of frothed milk to be dispensed by turning the Milk Frother Control Knob (10) to the right to increase and to the left to decrease.

Small Cup

Press the Cappuccino Small & Large Cup Select Button (22) once to brew a small cup of cappuccino, the 1 cup Cappuccino dispense light (20) will illuminate while dispensing; the programme stops automatically.

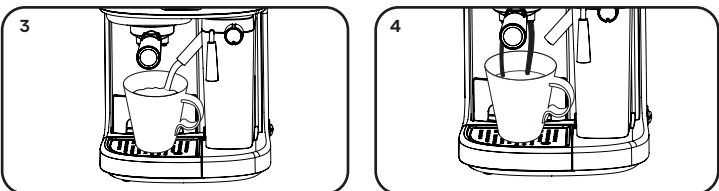

Filling The Milk Tank (7)

If you are preparing cappuccino or latte, remove the milk tank from the unit and open the milk tank lid (8) and fill between the "MIN" and "MAX" levels. Replace the milk tank lid and ensure the milk tank is re-attached securely to the unit.

Note: You can use the milk type of your preference, e.g. whole milk, low fat milk, organic or soy milk.

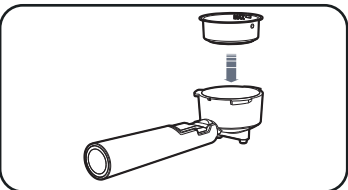

Filling With Coffee

- Fill the selected filter with fresh, fine ground espresso coffee (do not overfill).
Note: the ground coffee should not exceed the MAX amount mark.
- Tamp and compress the coffee firmly and evenly.
- Clean any excess coffee from the rim to ensure a proper fit under the brew head.
- Place the porta-filter into the brew head (4) ensuring it is properly locked and place a cup under it.

Large Cup

Press the Cappuccino Small & Large Cup Select Button (22) twice to brew a small cup of cappuccino, the 1 cup Cappuccino dispense light (20) and the 2 cup Cappuccino dispense light (21) will illuminate while dispensing; the programme stops automatically.

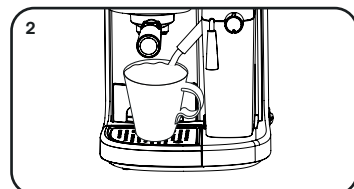

Preparing Latte

Before brewing Latte, adjust the quantity of frothed milk to be dispensed by turning the Milk Frother Control Knob (10) to the right to increase and to the left to decrease.

Small Cup

Press the Latte Small & Large Cup Select Button (25) once to brew a small cup of Latte, the 1 cup Latte dispense light (22) will illuminate while dispensing; the programme stops automatically.

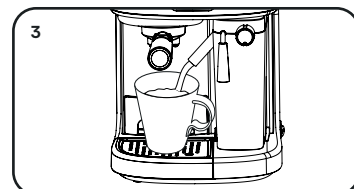

Large Cup

Press the Latte Small & Large Cup Select Button (25) twice to brew a large cup of Latte, the 1 cup Latte dispense light (20) and the 2 cup Latte dispense light (21) will illuminate while dispensing; the programme stops automatically.

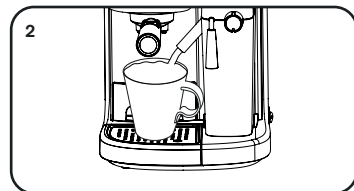

Preparing Frothed Milk

The unit also allows you to prepare frothed milk for other beverages, e.g. macchiato, hot chocolate etc or to add more foam to your beverage.

Press and hold the Cappuccino Small & Large Cup Select Button (22) for 3 seconds and when the required amount of frothed milk has been dispensed, press the Cappuccino Small & Large Cup Select Button (22) once again to stop.

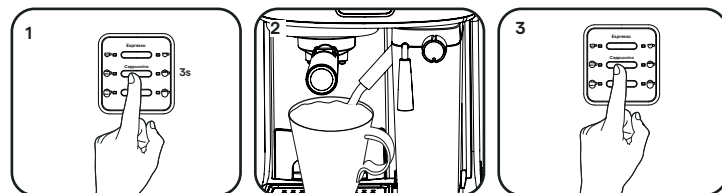

Once you have finished preparing your beverages with milk, you can either store the milk tank in the refrigerator (ready to be used next time) or dispose of the leftover milk

CAUTION: When making cappuccino, latte or frothing milk, please make sure the milk frother nozzle is positioned correctly inside/over the cup being used.

Note: If the machine is not operated for 15 minutes it will enter sleep mode.

You can press any button to wake up the machine.

Emptying Coffee Grinds from the Filters

To avoid the coffee filter falling from the Portafilter when emptying the coffee grinds, the flap in the Portafilter handle should be lifted and held in place with your thumb before upturning the Portafilter.

Descaling

When tap water is heated, calcium and other mineral deposits attach themselves to the inside of your Espresso maker. Excessive build-up of lime scale can reduce efficiency and also damage your machine. The frothing tube should be cleaned regularly as it is particularly vulnerable to lime scale blockage. Whenever possible we recommend using filtered or bottled water. If this is not possible and you use water straight from the tap, it will be necessary to de-scale the product regularly.

How to Descale

- When the 6 lights on the control panel are quickly flashing alternately, this is a reminder to descale your machine.
- Fill the water tank (2) with 600ml clean water and a de-scaling liquid solution suitable for coffee makers.
- Press the Espresso (19) and Latte (25) buttons simultaneously, the machine automatically starts the de-scaling mode, the six indicators then slowly flash alternately, after about half an hour, the six indicators will start to quickly flash alternately.
- Empty the water tank and refill it with 600ml clean water. Press Espresso (19) and Latte (25) buttons simultaneously again, the machine will continue the de-scaling mode with the six indicators slowly flashing alternately, after about half an hour the machine stops the descale mode and goes back into standby condition.

Note: You can press any functional buttons to cancel the de-scale warning and use as normal. However, we suggest that you continue with the descale or the appliance will continue to remind you to perform de-scaling after each use and the descale warning will only stop once a complete descale cycle has completed.

The default de-scale programme will trigger after 500 cycles but we recommend in hard water areas to descale after 40 cycles and in soft water areas after 80 cycles.

Care and Cleaning

- Unplug from the mains and allow coffee maker cool down completely before cleaning.
- Make sure the appliance has completely cooled down.
- Wipe the exterior with a clean, damp cloth. Do not use any abrasives or metal scourers as this will damage the finish on the unit.
- The Filters (11 & 12) and Water Tank (2) should be washed after each use by rinsing them under clean warm water.
- To keep the Portafilter (5) clean, we recommend you periodically run the machine with the Filter Holder in place, without coffee, using water only.
- Should the holes in the Filters become blocked with coffee grinds, use a fine bristled brush to help clean.
- When your coffee maker is not being used, we recommend that you do not leave the Portafilter (5) attached to the machine as this will reduce the life of the seal.
- Remove the Drip Tray and Grid (14) and Drip Tray Stand (15) from the appliance and rinse them under clean warm water.
- Clean any spill coffee, water and milk with a damp cloth or a damp sponge.
- Do not clean with alcohol or solvent cleanser. Never immerse the Espresso machine in water for cleaning.
- Dry all cleaned attachments thoroughly

IMPORTANT: Never wash your coffee machine accessories in a dishwasher.

Cleaning and Deep Cleaning the Milk Tank and Frothing Tube

Even though the milk reservoir with left over milk can be stored in the refrigerator, it is important to clean the milk tank (7) and the milk frothing nozzle (9) to avoid blockages.

NOTE: We also, recommend that the milk tank lid is dismantled regularly for deep cleaning.

- Remove the milk tank (7) from the unit.
- Remove the lid (8) from the milk tank (7).
- The milk frothing nozzle (9) can be detached by rotating and rinsed with clean warm water, then replace.
- Pour away any leftover milk, rinse and wash the milk tank (7) and milk tank lid (8) thoroughly with warm soapy water. Rinse and dry well. Do not use abrasive cleaners and scouring pads, as they will scratch the finish.
- Place a large empty cup under the milk frothing nozzle (9) turn the milk frother control knob clockwise to the clean position then press and hold the Latte Small & Large Cup Select and cleaning button (25) for 3 seconds and release to activate the clean function. The unit will start releasing steam through the frothing tube, let it run for a few seconds then press the Latte Small & Large Cup Select and cleaning button (25) once to stop the process.

Deep Cleaning the Milk Tank Lid

- Detach the milk frothing nozzle (9) by rotating anti-clockwise and then pulling.
- Remove the milk tube from the lid by pulling.
- Remove the steam nozzle at the back of the lid by rotating anti-clockwise and then pulling.
- Wash all removed parts with clean warm water and dry thoroughly before reassembling.
- The silicon flap on top of the milk tank should also be lifted and underneath it rinsed with clean water, dry thoroughly before replacing the silicon flap.

Cleaning the Brew Head, the Porta-filter and Filter

- Disconnect the machine from the power supply.
- Do not touch the metal parts until they have cooled.
- Remove the porta-filter and discard the coffee grounds. Wash both the porta-filter and filter with warm soapy water and rinse them well. Do not wash the porta-filter and filters in the dishwasher.
- Wipe brew head in the unit with a damp cloth or paper towel to remove any coffee grounds left from brewing.
- Secure the porta-filter without a filter back into the brew head, place a large cup under the porta-filter, press the espresso button once and let the unit brew with water only until it stops automatically.

Cleaning the Water Tank

Remove the water tank and discard any remaining water, wash the water reservoir with soapy water, rinse it well and wipe it dry. It is recommended to empty the water reservoir between uses.

Making Coffee and Choosing the Right Cup

Your Espresso Machine with Milk Frother allows you to create a variety of coffee drinks helping you to create the coffee shop experience in your own home. The diagrams on this page are a simple guide showing you the percentage of ingredients that make up each of the drink types.



Beverage Type Ratio

Beverage	Type	Icon	Volume
Espresso	Single		60ml
	Double		119ml
Cappuccino	Single		178ml
	Double		355ml
Latte	Single		296ml
	Double		474ml

Troubleshooting

Problem	Reason	Solution
Coffee doesn't dispense	Tank is empty.	Fill tank.
	Coffee grind is too fine.	Use medium grind coffee.
	Coffee is tamped too densely.	Tamp the coffee firmly, but do not use too much force.
Milk is not foamy after frothing or it is not coming out of the frothing tube	Out of steam.	Fill water tank.
	Milk is not cold enough.	Chill milk.
	Frothing tube blocked.	Clean milk tank and frothing tube.
Coffee comes out too quickly	Ground coffee is too coarse.	Use medium grind.
	Not enough coffee.	Add more coffee.
Weak coffee	Wrong filter fitted.	Fit appropriate filter.
	Coffee too coarse.	Use finer coffee.
Control lights flashing	Tank is empty	Fill tank

Registering Your 2 Year Guarantee

Your standard one year guarantee is extended for an additional 12 months when you register the product within 28 days of purchase with Morphy Richards. If you do not register the product with Morphy Richards within 28 days, your product is guaranteed for 1 year. To validate your 2 year guarantee register with us online at www.morphyrichards.co.uk

N.B. Each qualifying product needs to be registered with Morphy Richards individually. Please note that the 2 year guarantee is only available in the UK. Please refer to the one year guarantee for more information.

Your 1 Year Guarantee

It is important to retain the retailer's receipt as proof of purchase. Staple your receipt to this back cover for future reference.

Please quote the following information if the product develops a fault. These numbers can be found on the base of the product.

Model no. _____ Serial no. _____

All Morphy Richards products are individually tested before leaving the factory. In the unlikely event of any appliance proving to be faulty within 28 days of purchase, it should be returned to the place of purchase for it to be replaced.

If the fault develops after 28 days and within 12 months of original purchase, you should contact the Helpline quoting Model number and Serial number on the product, or write to Morphy Richards at the address shown.

You may be asked to return a copy of proof of purchase.

Subject to the exclusions set out below (see Exclusions), the faulty appliance will then be repaired or replaced as appropriate and dispatched usually within 7 working days of receipt. If, for any reason, this item is replaced or repaired during the 1 year guarantee period, the guarantee on the new item will be calculated from original purchase date. Therefore it is vital to retain your original till receipt or invoice to indicate the date of initial purchase.

To qualify for the 1 year guarantee, the appliance must have been used according to the instructions supplied. For example, crumb trays should have been emptied regularly.

Disclaimer

Morphy Richards has a policy of continuous improvement in product quality and design. The company, therefore reserves the right to change the specification of its models at any time.

For electrical products sold within the European Community. At the end of the electrical products useful life, it should not be disposed of with household waste. Please recycle where facilities exist. Check with your Local Authority or retailer for recycling advice in your country.